

# Personal single gas monitor

## MODEL: O3 SERIES

ATEX intrinsic safe design

Explosion proof: Exia IIC T4 (Alkaline battery)

Ingress protection rating: IP 67

**Model GP-03**

Combustible gas  
detection

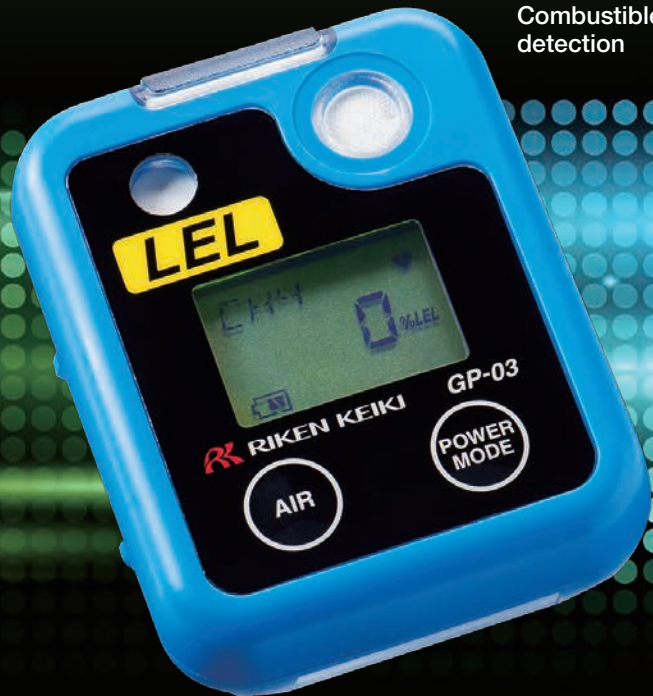

### Interchangeable battery

AAA(2) Alkaline battery is standard power source, Ni-MH battery can be installed as optional choice.

### Comfortable wearable design

Well-balanced weight and shape to ensure comfort wearing. Alligator clip prevents the unit from dropping.

Sensor, filter, and battery are replaceable.

Robust waterproof design and  
Intrinsically Safety rating make the O3 series  
the ideal gas monitor for  
many hazardous applications!



**Model OX-03**

Oxygen detection

**Model HS-03**

Hydrogen sulfide  
detection

**Model CO-03**

Carbon monoxide  
detection

### Application









- LEL monitoring for gas pipeline installations.
- LEL & CO monitoring while checking or installing gas meters.
- O2 & H2S monitoring while working in tanks, pits, or other confined spaces.
- CO monitoring in iron and steel plants.
- H2S monitoring around oil fields, refineries, petrochemical plants.

# Specifications

Model	GP-03	OX-03	HS-03	CO-03
Gas detected	Combustible gases	Oxygen	Hydrogen sulfide	Carbon monoxide
Detection principle	Catalytic combustion	Galvanic cell	Electro-chemical cell	
Detection range	0 ~ 100%LEL	0 ~ 40.0%	0 ~ 100.0ppm	0 ~ 500ppm
Increments	1%LEL	0.1%	0.5ppm	1ppm
Preset alarms	1st : 10%LEL 2nd : 50%LEL OVER : 100%LEL	1st : 19.5% 2nd : 18.0% OVER : 40.0%	1st : 5.0ppm 2nd : 30.0ppm STEL : 5.0ppm TWA : 5.0ppm OVER : 100.0ppm	1st : 25ppm 2nd : 50ppm STEL : 200ppm TWA : 25ppm OVER : 500ppm
Types of alarm *1	Gas alarms: 2 preset alarms, Over scale alarm, STEL, TWA Trouble alarms: Sensor disconnection, Low battery, Calibration error, Clock error, System error			
Alarm method	Latching	Latching	Latching	Latching
Display of alarm	Gas alarms: Flashing LEDs, Buzzer, Flashing gas value, Vibration Trouble alarms: Flashing LEDs, continuous buzzer, display of error message			
Operating temp. & humidity	-20 ~ +50°C [-4°F ~ 122°F] 0 ~ 90%RH (Non-condensing)	-20 ~ +50°C [-4°F ~ 122°F] 0 ~ 95%RH (Non-condensing)	-20 ~ +50°C [-4°F ~ 122°F] 16 ~ 85%RH (Non-condensing)	
Power source	2 AAA size Alkaline battery (Optional AAA size Ni-MH battery [Eneloop])			
Continuous operation *2	Alkaline battery : Approx.35 h Ni-MH battery : Approx.30 h	Alkaline battery : Approx.3000 h Ni-MH battery : Approx.2000 h		
Response time	90% response within 30 sec	90% response within 20 sec	90% response within 30 sec	
Ingress proof	IP 67			
Explosion proof	Alkaline dry battery version : Exia II CT4 Ni-MH battery version : Exia II CT3			
Approvals	IECEX, ATEX			
Dimension & weight	Approx. 57(W) × 70(H) × 26(D) mm [2.1(W) × 2.64(H) × 0.94(D) inches] with rubber protection cover, 80g [2.8 ounces]			
Function	Manual LCD backlight (Automatically ON when alarming), Peak value, Data logging, Time, CAL alarm, BUMP alarm			

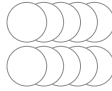
\*1 STEL and TWA alarms are available on HS-03 and CO-03 only. \*2 No alarm, no light at 25°C

# Accessories

<b>Standard</b>	Rubber protection cover 	<b>Optional</b>	Hand strap 
	Alligator clip 		Battery charger 
	Alkaline dry battery 		Filter 
			Ni-MH battery 
	Belt clip 		Data logger management program 

# Outer dimension

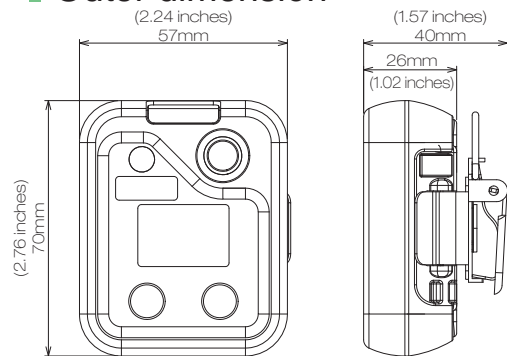

# Data logger download



# RIKEN KEIKI Co.,Ltd.

2-7-6 Azusawa, Itabashi-ku, Tokyo 174-8744, Japan  
 Phone : +81-3-3966-1113  
 Telefax : +81-3-3558-9110  
 E-mail : intdept@rikenkeiki.co.jp  
 Web site : http://www.rikenkeiki.co.jp

★ Distributed by: